

Visual Inspection of Can Seams in Home Food Preservation

The information in this publication is provided to assist you in the use of cans as containers for home food preservation. This material is not a recommendation for the use of cans instead of jars. It is meant to help you judge how well this type of container will work for you.

The “how-to” instructions for preserving specific types of foods in cans are not included in this publication. The instructions for canning fish in cans can be found in the publication, “Canning Fish in Cans,” FNH-00125, and the instructions for canning meat in cans are in “Canning Meat in Cans,” FNH-00227. Instructions for setting up and adjusting a can sealer can be found in the companion publication titled “Assembling a Can Sealer,” FNH-00022. Contact your local Cooperative Extension Service or Marine Advisory office for these publications as well as current recommendations and other publications about home food preservation.

Equipment

Can sealer: Read manufacturer’s instructions about assembling and adjusting the sealer. Also read the Cooperative Extension Service publication “Assembling a Can Sealer” for detailed information about home can sealers.

Cans and lids: Cans most commonly available in Alaska are the 1-pound (size: 301 × 408) and ½-pound (size: 307 × 200.25) sizes, also called Alaska salmon cans. Two types of cans may be purchased: tapered, with no side or bottom seams (also called two-piece cans), or three-piece cans, with a side and bottom seams. Alaska salmon cans have an enamel lining that is appropriate for a low-acid food like fish.

Pressure canner: Read manufacturer’s instructions and have your dial gauge tested for accuracy each year at your Cooperative Extension Service district office.

Inspecting cans before use

Check all cans, lids and lid-sealing material (gasket compound) before use in food preservation. Do not use cans or lids that are bent or dented, especially if there is damage to the edges where the lid and can seam are formed.



Examine can side and bottom seams for damage. Then check the lid sealing material. The sealing material should go completely around the lid sealing edge.

Do not wash can lids before use. If the lids are dusty, wipe them with a damp cloth.

Do not boil or heat lids before use. The sealing material on can lids is not prepared in the same manner as jar lids.

Damaged lids, lid sealing material or can bodies may prevent airtight seams and allow spoilage of the food after processing.

The can sealer

The extra piece of equipment needed for using cans in home food preservation is the manual home can sealer. Read the can sealer manufacturer’s instructions and the Cooperative Extension Service publication “Assembling a Can Sealer” carefully. You will need to know:

1. The parts of the sealer.
2. How to put together and adjust the sealer for the size can you plan to use.
3. How to adjust the seam rollers and turntable for good quality seams.
4. How to visually inspect your can seams and adjust the sealer when problems occur.

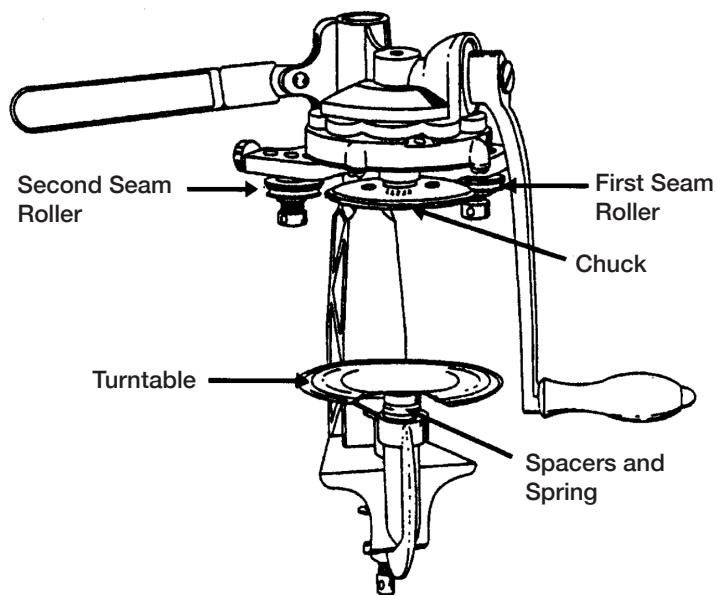

Visual seam defects

Visual seam defects are seen on the outside of the can seam. These defects include droop, vee, sharp seam, cut seam, incomplete seam and false seam. Each can should be inspected for visual seam defects before processing. Cans need to be free of all visual defects to be acceptable.

If visual defects are present, the can seam is unacceptable. An unacceptable or defective can seam could (1) prevent the seam from being airtight, (2) cause loss of the canned food through spoilage or (3) be a health hazard if the bacteria that causes botulism enters the can through the defective seam.

Seams that do not pass the visual inspection for defects cannot be corrected by running them through the sealer a second time. The can sealer problem must be corrected. The contents of the can must be packed into a new can and the can reprocessed according to recommended instructions.

Remember! When defects are discovered, it is essential to determine the cause of the defects and to correct the problem.

Droop

Seam droop is a smooth overhang along the bottom of the normal seal. Droop gives the bottom edge of the seam a scalloped look. This defect may occur at any point around the seam, but it is found most often where the can seam crosses the side seam of the can body (three-piece cans). A very slight droop at the side seam may be normal because of the extra thickness at this point.

Read sealer instructions before adjusting for defective seams.

Possible Causes	Possible Solutions
Turntable pressure is too great.	Decrease turntable pressure. Check number of spacers for can size.
First seam roller operation was too loose.	Tighten first seam roller operation.
Food is trapped in seam.	Clean can edge carefully before seaming on lid.
Cans are defective (bent or dented).	Inspect cans for damage before using.
First seam roller is worn.	Replace seam roller.

The can seam

A double seam attaches the can lid to the can body. The seaming operation, which has two parts, is done with a can sealer.

The three-piece can's double seam has five layers of metal (seven at the side seam) that are curled or folded and then pressed together. The double seam on a two-piece can has a double seam made of five layers of metal that are curled or folded and then pressed together. A two-piece can has no side or bottom seams.

The can sealer's first seam roller operation interlocks the lid edge and sealing material with the can body edge by curling them together. It is important that this first seaming operation be correctly done, because it cannot be corrected during the second part of the seaming operation.

The can sealer's second seam roller operation flattens and smooths the seam by pressing the layers of metal tightly together. This operation also squeezes the lid sealing material into the spaces between the metal to give an airtight seal.

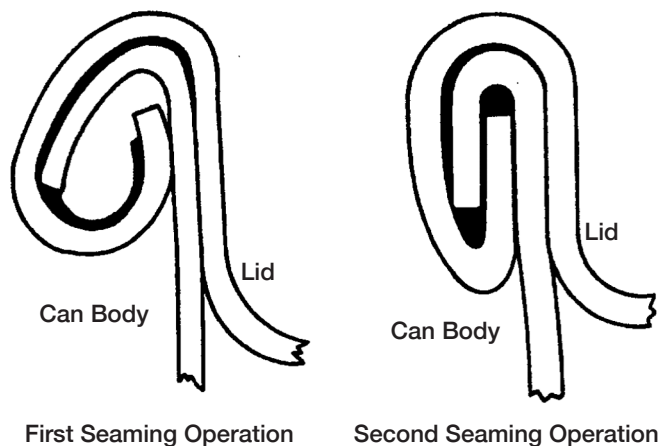

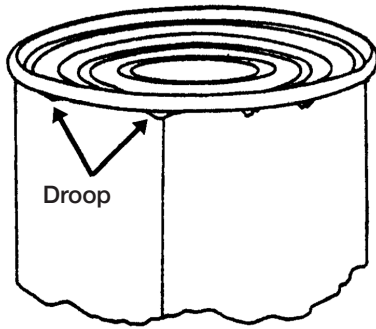

Vee

Seam vee is a sharp, pointed overhang along the bottom edge of the normal seam. The presence of vees means the lid and can body edges are not interlocking correctly.

Read sealer directions before adjusting for defective seams.

Possible Causes	Possible Solutions
Turntable pressure is too great.	Decrease turntable pressure. Check number of spacers for can size.
First seam roller operation was too loose.	Tighten first seam roller operation.
Food is trapped in seam.	Clean can edge carefully before seaming on lid.
First seam roller operation was too tight.	Loosen first seam roller operation.
First seam roller is worn.	Replace seam roller.

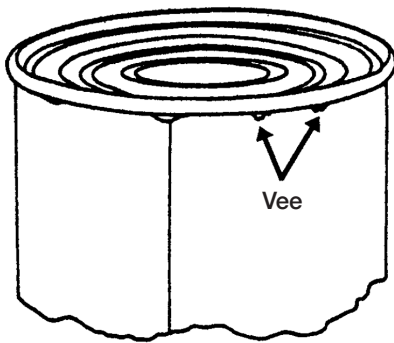

Sharp seam and cutover

A sharp seam is a sharp edge at the top inside portion of the seam. A sharp seam can usually be felt by running a finger around the inside part of the lid seam. This defect can be the first indication of cut-over, where the seam is fractured. Sharp seam and cut-over have the same possible causes and possible solutions.

Read sealer directions before adjusting for defective seams.

Possible Causes	Possible Solutions
First or second seam roller operations were too tight.	Loosen first and/or second seam roller operation.
Food is trapped in seam.	Clean can edge carefully before seaming lid.
Turntable pressure is too great.	Decrease turntable pressure. Check number of spacers needed for can size.
Seam rollers and/or chuck are worn.	Replace seam rollers and/or chuck.

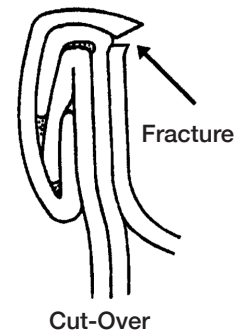
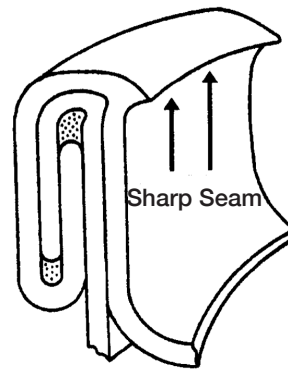

Cut seam

A cut seam is an extremely tight seam. The outer layer of the seam is fractured.

Read sealer instructions before adjusting for defective seams.

Possible Causes	Possible Solutions
First and second seam roller were too tight.	Loosen first and second seam roller operations.

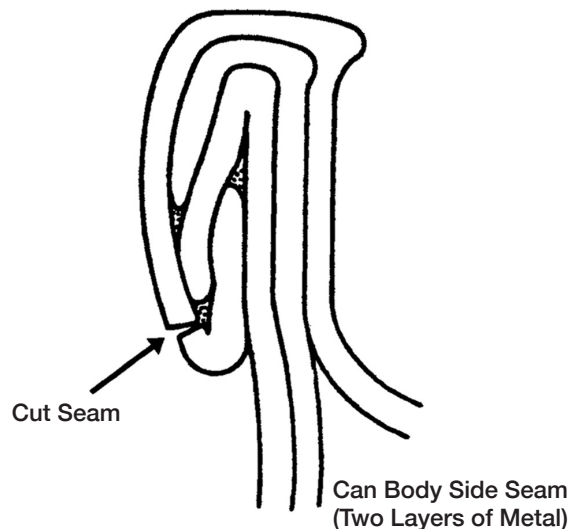

Incomplete seam

The incomplete seam is a defect where the seam is unfinished or loose in sections around the completed seam.

Read sealer instructions carefully before adjusting for defective seams.

Possible Causes	Possible Solutions
Turntable pressure is too high or too low.	Check sealer instructions for number of spacers needed for can size.
Seaming chuck is worn.	Replace chuck.
Seam rollers are not rotating freely.	Clean, oil or repair seam rollers so they rotate freely.
There is oil or grease on seaming chuck or turntable.	Clean seaming chuck and/or turntable.

Possible Causes	Possible Solutions
Lid or can edges are bent or damaged.	Inspect cans and lids for damage before using.
Food is trapped in seam and/or can is overfilled.	Clean can edge carefully before seaming. Check fill of can,
First seam roller operation was too loose.	Tighten first seam roller operation.
Second seam roller operation was too tight.	Loosen second seam roller operation.

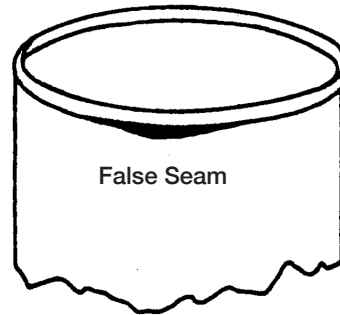
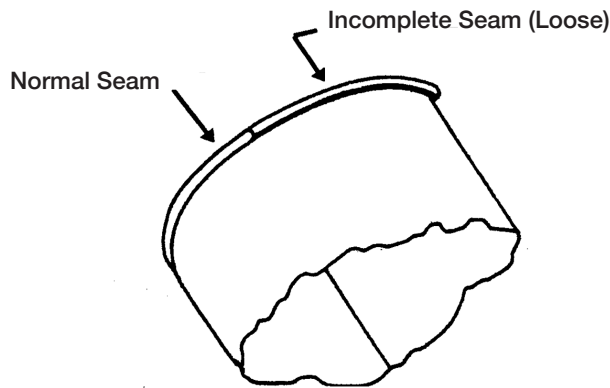

False seam

The false seam is a serious defect that will cause leakage of food from the can. Visible on the outside of the can by close inspection, the lid and can edges are pushed flat against the can but are not hooked together.

This work was partially sponsored by the Office of Sea Grant, NOAA, U.S. Department of Commerce, under Grant No. NA81AA-D-00025 and the Virginia Sea Grant Program through Project A/AS-1. The U.S. government is authorized to produce and distribute reprints for governmental purposes, notwithstanding any copyright that may appear hereon.

www.uaf.edu/ces or 1-877-520-5211

Leif Albertson, Extension Faculty, Health, Home and Family Development. Originally written by Kristy Long, former Extension Foods Specialist.



Published by the University of Alaska Fairbanks Cooperative Extension Service in cooperation with the United States Department of Agriculture. UAF is an AA/EO employer and educational institution and prohibits illegal discrimination against any individual: www.alaska.edu/nondiscrimination

©2021 University of Alaska Fairbanks.

08-02/KL/11-21

Reviewed July 2020