

POST TEST

Going to Egg Island: Adventures in Grouping and Place Values

Math in a Cultural Context*

UNIVERSITY OF ALASKA FAIRBANKS

Student Name:
Grade:
Teacher:
School:
Location of School:
Date:

*This project has been funded by the U.S. Department of Education, *Returning the Gift: Systemic Implementation of an Effective Culturally Based Math Curriculum and Professional Development Program*, Jerry Lipka, P.I.

Total Score:

1. Write the answer in the box. You can use numbers, words, or pictures to show your work.

$$\begin{array}{r} 17 \\ + 42 \\ \hline \end{array}$$

2. Write the answer in the box. You can use numbers, words, or pictures to show your work.

$$\begin{array}{r} 38 \\ - 15 \\ \hline \end{array}$$

3. The number below, 16, shows how many dots there are altogether. Circle dots to show how much the underlined part of 16 really means:

16

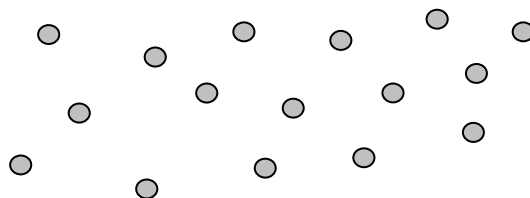

4. Write the answer in the box. You can use numbers, words, or pictures to show your work.

$$\begin{array}{r} 39 \\ + 13 \\ \hline \end{array}$$

5. Write the answer in the box. You can use numbers, words, or pictures to show your work.

$$\begin{array}{r} 43 \\ - 25 \\ \hline \end{array}$$

6. Mary has 7 dolls. She wants to have 12 dolls. How many more does she need to have 12 dolls? You can use numbers, words, or pictures to show your work and answer.



7. Betsy spent \$9.00 on a video rental. She has \$6.00 left. How much money did Betsy have to start with? You can use numbers, words, or pictures to show your work and answer.



8. & 9. The Kingdom of Four Counting System has flat blocks, which equals 16 units, long blocks, which equals 4 units, and individual blocks, which is 1 unit.

The Kingdom of Four Counting System

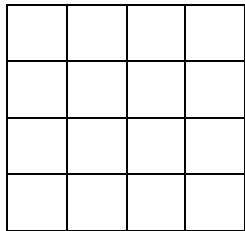

Flat = 16



Long = 4



Individual Unit = 1

You have 29 units. Below is one way to group these units in the Kingdom of Four Counting System. Find **TWO OTHER WAYS** to group the 29 units.

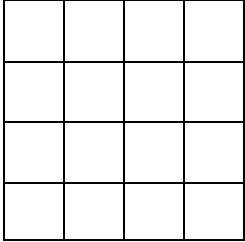
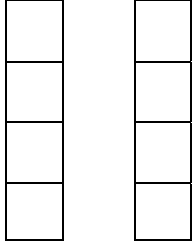
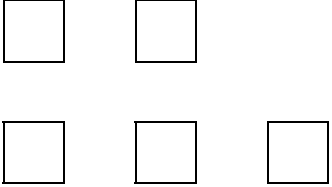
One Solution		+		+	
	or				
29 =	1 flat	+	2 longs	+	5 units
29 =		+		+	
29 =		+		+	

10. Remember that in The Kingdom of Four Counting System:

The Kingdom of Four Counting System

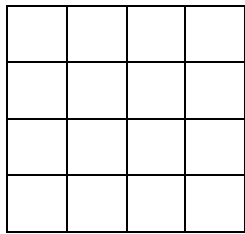

Flat = 16



Long = 4



Individual Unit = 1

In the Kingdom of Four blocks must be traded using two rules:

- trade units for longs.
- trade longs for flats.

You have 7 units and 3 longs as shown below:

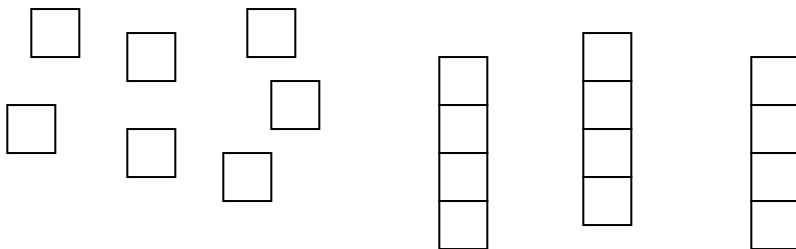

Trade using the rules above. What blocks do you have now? Write or draw your answer in the box below:

11. What is the total value of all the ●(dots) in the chart below?

Tens and Ones Chart

10's	1's
●	● ● ● ● ● ●



Write the answer in the box below:

12. Show **31** by putting (dots) ● in the tens and ones chart below.
Use both columns.

Tens and Ones Chart

10's	1's

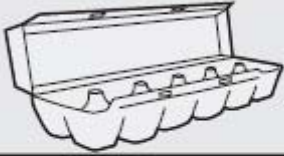

13. What is the total value shown by the checks in the chart below?

12's	1's
 ✓✓	 ✓✓✓ ✓✓✓

Write the answer in the box below:

14. Sally went egg hunting and found 17 eggs.

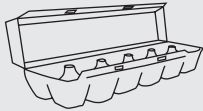
Show this amount using both columns in the twelves and ones chart below. You may use numbers or the ● (dots) for your answer.

12's	1's
	

15. Below is a 20's, 5's, and 1's chart.

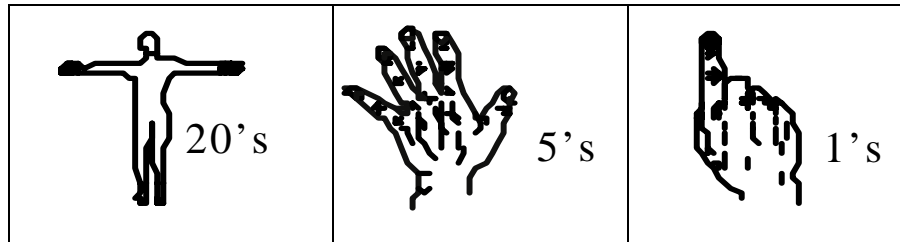

A person has 10 fingers and 10 toes. So a person equals 20 units. A hand equals 5 units, and a finger equals 1 unit.



If we had one person, two hands, and three fingers, how many units would that be? Write the answer in the box.

16 & 17. You have **47** units. We provide one example below. Now, show two other ways to represent **47** units in the chart below.

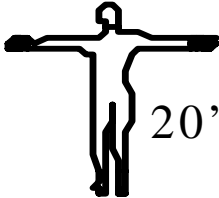
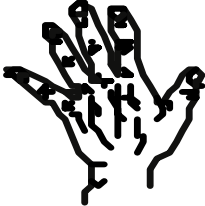
Twenties, Fives, and Ones Chart

	 20's	+	 5's	+	 1's
One Solution: 47=	1 PERSON	+	2 HANDS	+	17 FINGERS
47=		+		+	
47=		+		+	